

EDWinXP – An Integrated EDA Software Package

EDWinXP (Electronic Design For Windows) is a CAD/CAE Software package of seamlessly integrated, task oriented modules covering all stages of the electronic circuit design process-from capturing the idea of a circuit in the form of schematic diagram to generate a full set of documentation for manufacturing and assembly of PCBs. Additionally the package includes various validation tools ensuring correctness and integrity of designed circuits. Complete design information is stored in the integrated project database, simultaneously accessible by schematic diagram editor, analog/digital, mix-mode circuit simulator, PCB layout editor, board level analysis and fabrication output managers. Front and back annotation of all design changes is fully automatic. EDWinXP comes with extensive part library which may be updated, customized and enhanced with the help of library editor.

Modules (EDWinXP)

- Schematic Editor
- Library Editor

- Mixed Mode Simulator
- EDSpice Simulator (SPICE based simulator)

- 8051 Microcontroller Kit
- AVR Kit
- PIC Microcontroller Kit
- VHDL Co-Simulation and Model Generators

- PCB Layout Editor
- Thermal Analyzer
- Electromagnetic Analyzer
- Field Analyzer
- Signal Integrity Simulation

- Fabrication Manager
- 3D Editors and Viewers

Schematic Diagram Editor:

The schematic diagram editor contains a full set of manual and automated tools for placement of circuit elements on the diagram and for routing the connection. Additional graphical and textual information may be created in the form of design notes.

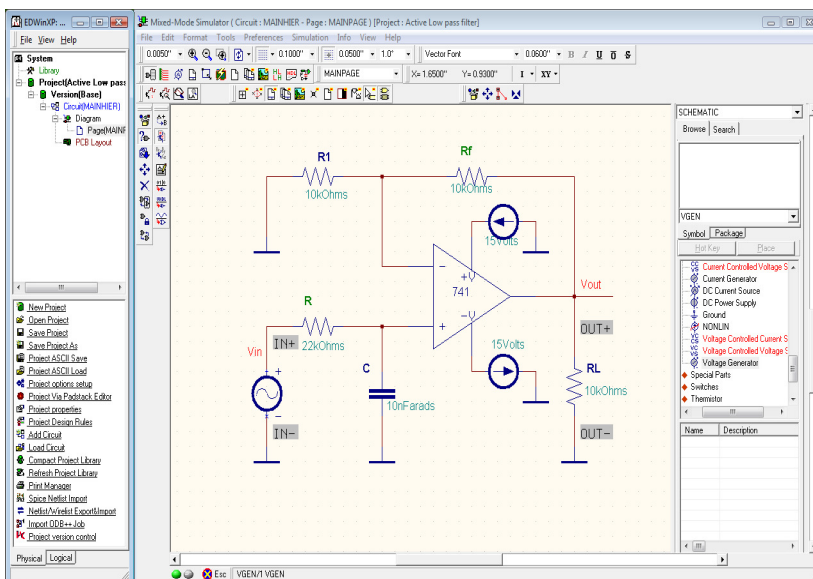

Features:

- Top down hierarchical circuits (99)
- Customizable component browser
- Definable connection and bus width
- Intelligent and interactive routing
- Auto packaging
- Instant packaging
- Smart auto placer
- Circuit DRC
- Filter designer
- Page/design notes
- Block diagram elements
- Truth table to diagram converter
- VHDL code to diagram converter

Circuit Simulator:

The functioning of the circuit may be tested with the help of integrated simulators in EDWinXP. Mixed mode simulator, the system's native circuit level analyzer and EDSpice, the full implementation of XSPICE as defined by Georgia Tech are two simulators in EDWinXP.

Mixed mode simulator supports TD, DC, AC, Parameter sweep, Fourier, Monte Carlo and sensitivity analyses of analog, digital, and mixed-signal circuits.

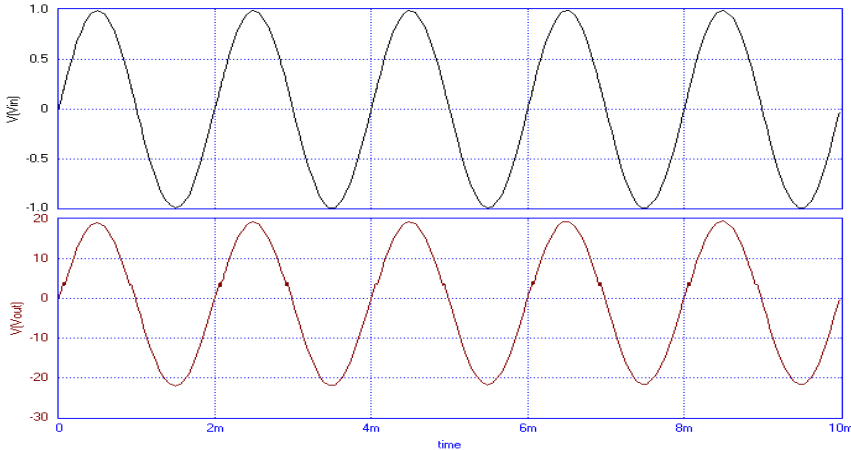

Features:

- Mixed mode Simulator
- EDSpice Simulator
- Logic Analyzer
- Multi channel Oscilloscope
- EDSpice interactive Interpreter
- Circuit File Editor
- Instant Probes
- Model Generators
- VHDL to SPICE Model
- VHDL to Mixed Mode

SPICE Net list Generation from schematic:

Active low pass filter (Netlist View)

```

*
V9 0 7 15
V8 6 0 15
R7 0 4 10k
R5 1 0 10k
X1 8 1 6 7 4 TL032_30
C2 0 8 10n
V3 5 0 AC SIN ( 0 1 100k 0 0 )
R4 4 1 10k
R6 8 5 22k
*CODE MODEL DEFINITIONS
*
.END
    
```

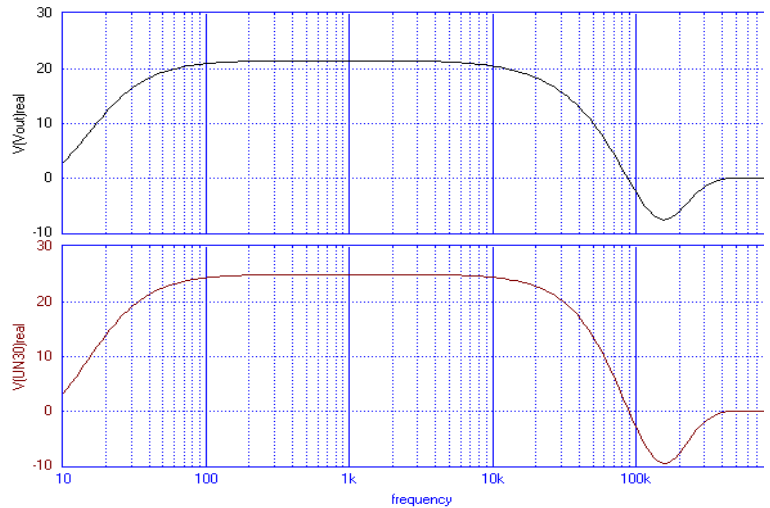

Microcontroller simulation kit:

The Kit contains project databases designed to illustrate functionality of 8051, AVR AT 90S2313, PIC16C5X, and PIC16X84. It uses MMI technology that enables edition and compilation of programs in C and assembly language, and it also allows debugging the code in real time. The kit contains series of instrumental models such as memories, interrupt generators, serial/parallel pattern generators, 7-segment displays etc. for generating parallel and serial binary data patterns and asynchronous hardware interrupts.

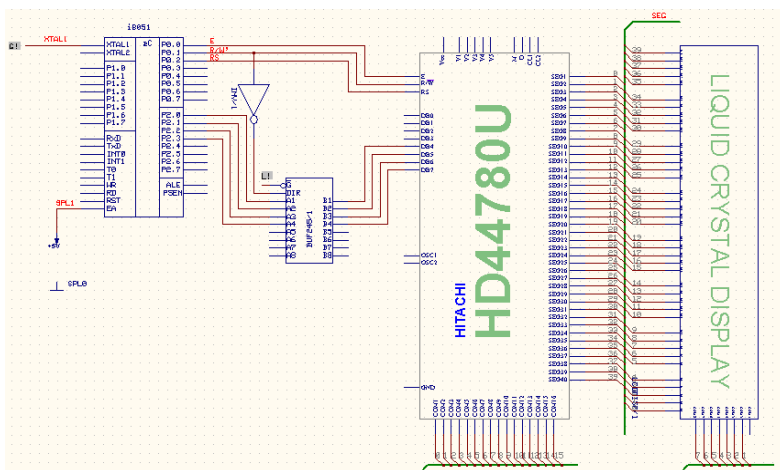

```

C Editor Assembler Editor Listing View Hex Editor (ROM) Hex Editor (EEPROM) Disassembler Output

void Delay(int Time);
int Busy(void);
void Command (int Value);
void Display (int Value);

void eeprom_write (unsigned char Address, unsigned char Data);
unsigned char eeprom_read (unsigned char Address);

void init (void)
{
    _asm
    _config_LP_OSC
    org 0x2100
    DE "EDWinXP-Ver 1.50"
    org 0x0005
    _endasm;
}

void main(void)
{
    
```

VHDL Editor and Compiler:

VHDL source files (Level 0 syntax) may be created with VHDL editor. This may then be compiled and imported to EDWinXP as a project. This project may then be exported to netlists of the format CUPL, XILINX, JEDEC etc.

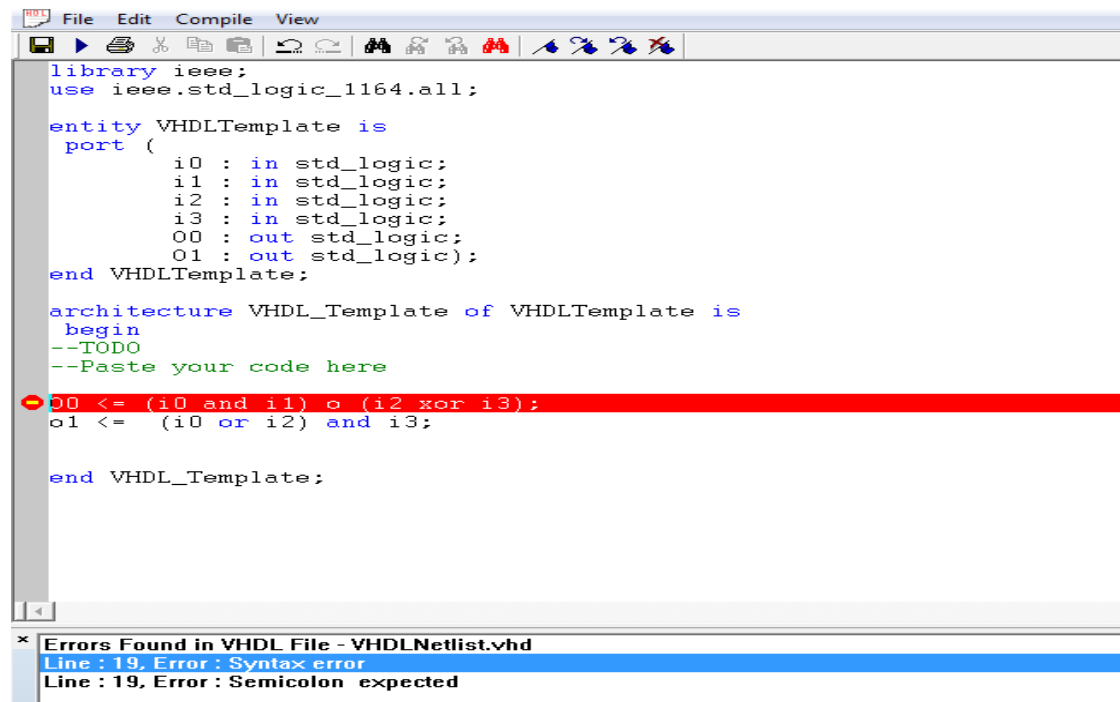

```
library ieee;
use ieee.std_logic_1164.all;

entity VHDLTemplate is
  port (
    i0 : in std_logic;
    i1 : in std_logic;
    i2 : in std_logic;
    i3 : in std_logic;
    O0 : out std_logic;
    O1 : out std_logic);
end VHDLTemplate;

architecture VHDL_Template of VHDLTemplate is
  begin
  --TODO
  --Paste your code here
  O0 <= (i0 and i1) o (i2 xor i3);
  O1 <= (i0 or i2) and i3;

end VHDL_Template;
```

PCB Layout Editor:

EDWinXP project supports design of 32-layer boards. Components are created automatically as a result of packaging executed while editing the schematic diagram of the circuit. Location and orientation of components is defined either by manual relocation to desired position or with the help of the auto placer.

Traces may be routed manually with automatic via insertion whenever a routing layer is changed. Sixteen types of user defined via pads are supported. A dedicated “full board” auto router module is integrated with the PCB layout editor. Insertion of air gaps and the thermal pads on artworks is automatic. Design rules violation, clearance errors and missing or incomplete connections are also detected automatically.

All changes introduced in the circuit design are automatically back annotated to schematic diagram.

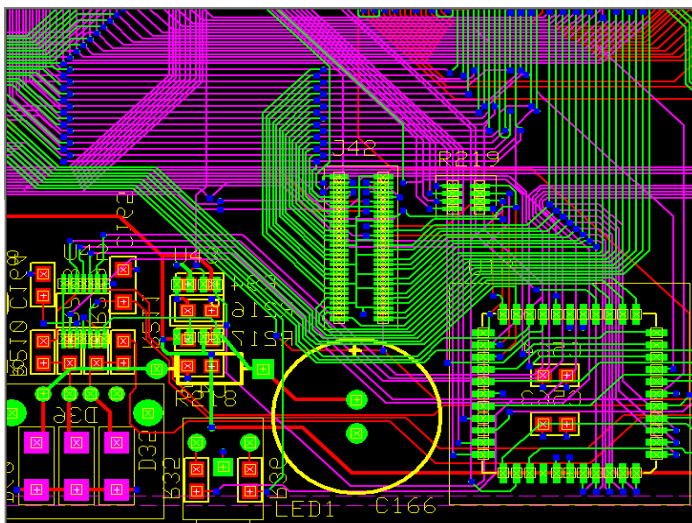

Features:

- 32 layers
- Smart auto placer
- Auto router
- Online trace clearance check
- Trace length and width trimming
- DRC
- Test point
- Connection check
- Automatic correction of selected clearance errors
- Automatic clearance correction after routing and rerouting
- Through holes and buried vias
- 3D view of layout

Board Analyzers:

Thermal analyzer

The temperature distribution on a finished PCB may be analyzed graphically with the help of thermal Analyzers. The result of the analysis is displayed using Isotherms or color mapping schemes.

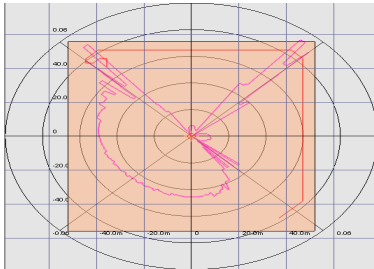

Electromagnetic field analyzer

Electromagnetic analyzer presents graphically the Predicted intensity of electromagnetic Fields inside and Outside board boundaries.

The signal integrity analyzer detects distortion Noise and Crosstalk for critical signals.

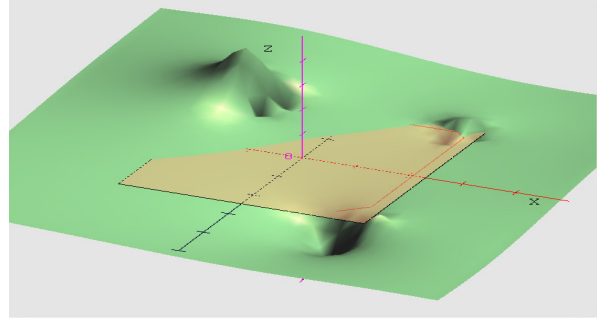
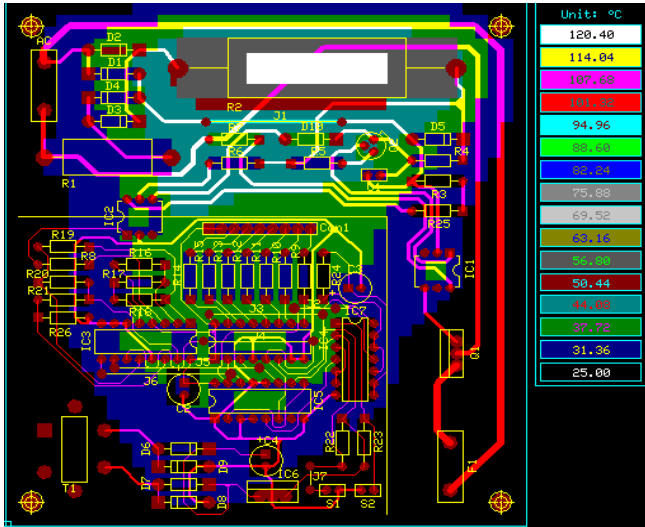

Fabrication Manager:

All CAM function of EDWinXP are grouped in this module. The User has the option to add targets, coupons, thieving and Venting areas. Copper pour areas are checked for possible shorts Or area isolated by air gaps. Automatic or manual copper Removal is also implemented. Final artworks are prepared for Photo plotting.

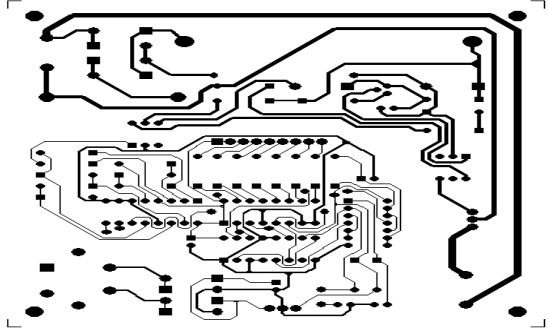
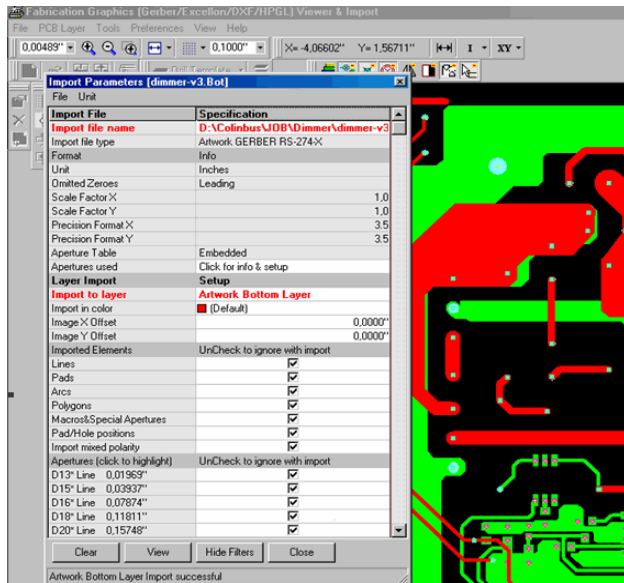

Exports:

- ODB++ Export
- DXF output
- EDIF version 2.0
- Export CNC data in G-CODE
- Spectra and maxroute auto routers
- Xilinx netlist
- JEDEC netlist
- GERBER and many others.....

Imports:

- ODB++ import
- DXF
- SPICE netlist (SPICE3F5 & XSPICE)
- VHDL (Level '0' syntax)
- Geber ASCII (Reverse Engg)
- Orcad PCB II wirelist and many others.....

3D Editor and viewer:

EDWinXP may present designed PCB in “real life” three dimensional views. In order to make it possible, 3D views of component packages (created according to IPC, JEDEC and EIA standards.) are included in the system part library. Tools are provided in library editor to create and edit 3D views for newly created packages.

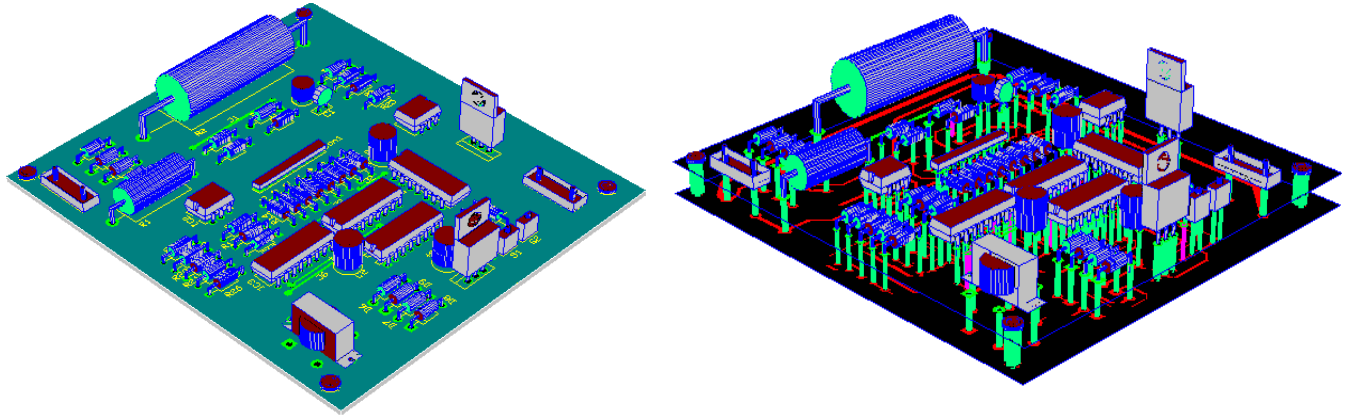

Library Editor:

EDWinXP component libraries may be updated, customized or enhanced with the help of library editor. Functionality of this module allows definition of graphical representation of components in schematic diagram(symbol editor) and on printed circuit board (package Editor). These elements are included then in the component description, which also contains the packaging information, thermal parameters and link to simulation modules.

Library Browser : (C:\EDWINXP\LIB)

Library View Help

Part Symbol Package Padstack

Options	Values
Name	*
Library	XILINX.PART
Description	
Symbol	
Package	
Package Type	
Manufacturer	
Technology	
Type	

Symbol Libraries

- I_XILINX.SYMBOL
- I_TOSHBA.SYMBOL
- I_XILINX.SYMBOL
- I_ZLGMCR.SYMBOL
- INSTRUMENTS.SYM
- MISC.SYMBOL
- MIXMODE.SYMBOL

PLD3256XL

- FPGA2100A
- FPGA2100X
- FPGA2C2S300
- FPGA2C2S50
- GRY300XCS
- PLD3128XL
- PLD3256XL
- PLD9572
- PROM1800

EDSpice - Symbol: <PLD3256XL> as Circuit Element

File Search Editors Help

Circuit Element

Element Code:

Assign Element to this Symbol

ReDraw Save Exit

Element&Model Code Subcircuit

Cancel Assignment

Viewer[QFP240] [C:\EDWINXP\LIB\SI

user ref.

COMPNAME

COMPDESC

PARTIAL LIST OF EDUCATIONAL INSTITUTES USING EDWinXP IN INDIA

<p>IIMT ENGINEERING COLLEGE, GREATER NOIDA IIMT ENGINEERING COLLEGE, MEERUT COLLEGE OF ENGINEERING & TECHNOLOGY ,IILM ACADEMY FOR HIGHER LEARNING GREATER NOIDA G.L.Bajaj ,GREATER NOIDA KNGD ,GHAZIABAD H.R.Inst,GHAZIABAD RKGIT,GHAZIABAD R. D. ENGINEERING COLLEGE, GHAZIABAD LORD KRISHNA COLLEGE OF ENGINEERING KRISHNA ENGINEERING COLLEGE, GHAZIABAD GNIT GIRLS INSTITUTE OF TECH GREATER NOIDA SRM UNIVERSITY MODINAGAR CAMPUS R.K.G.E.C, PILKHUA, UTTER PRADESH LDC INSTITUTE OF TECH, ALLAHABAD ALLAHABAD INSTITUTE OF ENGG & TECH, ALLAHABAD K.P. ENGINEERING COLLEGE, AGRA HMFA, ALLAHABAD BHAGWAN PARSHURAM INSTITUTE OF TECH, ROHINI JAIPUR ENGINEERING COLLEGE, JAIPUR GLOBAL INSTITUTE OF TECHNOLOGY,JAIPUR R.N.MODI,KOTA SEEDLING ACADEMY ,JAIPUR PACIFIC INSTITUTE OF TECHNOLOGY, UDAIPUR JYOTI VIDYAPEETH WOMEN'S UNIVERSITY, JAIPUR MEWAR UNIVERSITY, CHITTORGARH BANSAL SCHOOL OF ENGG & TECH, JAIPUR KIIT ,GURGAON, HARYANA GURGAON INST OF TECH & MGT. SOMANY INST OF TECH & MANAGEMENT WORLD INST OF TECH, GURGOAN GURGAON COLLEGE OF ENGINEERIG, GURGAON TEK CHAND MANN COLLEGE OF ENGG, SONEPAT SHANTI NIKETAN ENGINEERING COLLEGE, HISSAR RAO PAHLAD SINGH COLLEGE OF ENGG, MOHINDERGAR KOUSTUV INST OF SELF DOMAIN,BHUBHNESHWAR COLLEGE OF ENGG ,BHUBHNESHWAR CHHATTISGARH INSTITUTE OF TECHNOLOGY, RAJNANDGAON M.M. FOUNDATION, RAIPUR SHRI SHANKRACHARYA GROUP OF COLLEGES, BHILAI Dr. C.V. RAMAN UNIVERSITY, BILASPUR GURU GHASIDAS VISHWAVIDYALAYA, BILASPUR KRUTI INSTITUTE OF TECH & MGT, RAIPUR CENTRAL COLLEGE OF ENGINEERING & MGT, BILASPUR LAKHMI CHAND INSTITUTE OF TECH, RAIPUR DEV BHOOMI INSTITUTE OF TECHNOLOGY, DEHRADUN IIIT DESIGN AND MANUFACTURING, JABALPUR SOMAYA COLLEGE OF ENGINEERING, MUMBAI SARASWATI COLLEGE OF ENGINEERING, NAVI MUMBAI RAMRAO ADIK INST OF TECH, NAVI MUMBAI DR D Y PATIL COLLEGE OF ENGINEERING, PIMPRI, PUNE SINGHAD COLLEGE OF ENGINEERING, PUNE K J SOMYA, SHELUM, MUMBAI.....</p>	<p>BIT INSTITUTE OF TECHNOLOGY – HINDUPUR NITTE COLLEGE OF ENGINEERING – NITTE Dr. AMBEDKAR INSTITUTE OF TECHNOLOGY – BANGALORE DAYANAND SAGAR COLLEGE OF ENGINEERING – BANGALORE ARUNAI ENGINEERING COLLEGE – THIRUVANNAMALAI SIR M. VISVESVARAYA INSTITUTE OF TECH -BANGALORE BAPUJI COLLEGE OF ENGINEERING – DAVANAGERE CUMMINS COLLEGE OF ENGINEERING FOR WOMEN – PUNE MEERUT INSTITUTE OF ENGINEERING & TECHNOLOGY – MEERUT A.I.T. COLLEGE – PUNE GENBA SOPANRAO MOZE ENGINEERING COLLEGE, PUNE B.V. BHOMARADDI COLLEGE OF ENG & TECH, HUBLI REGENCY INSTITUTE OF TECHNOLOGY, PONDICHERRY DR. SAMUEL GEORGE INST OF ENG & TECH, MARKAPUR SRI VENKATESWHARA COLLEGE OF ENG & TECH, CHITTOOR ANJUMAN INSTITUTE OF TECHNOLOGY, BHATKAL VEMANA INSTITUTE OF TECHNOLOGY, BANGALORE MOTICHAND LENGADE BHARATESH POLYTECHNIC, BELGAUM JATIPITA ENGINEERING COLLEGE, ADILABAD M.G.R. ENGINEERING COLLEGE, CHENNAI NMAM INSTITUTE OF TECHNOLOGY – UDUPI VEL MULTIMEDIA COLLEGE, CHENNAI GOVT. COLLEGE OF ENG, SREEKRISHNAPURAM, PALAKKAD MARIAN ENG COLLEGE, KAZHAKOOTAM, TRIVANDRUM L.B.S. INST OF TECH FOR WOMEN, POOJAPPURA, TRIVANDRUM GOVT. ENGINEERING COLLEGE, BARTON HILL, TRIVANDRUM MOHANDAS COLLEGE OF ENG AND TECH, TRIVANDRUM VISWAJYOTHI COLLEGE OF ENG, ERNAKULAM RAJAGIRI SCHOOL OF ENG & TECH, KAKKANAD, COCHIN SREE NARAYAN GURUKULAM COLLEGE OF ENGG, ERNAKULAM SAINTGITS COLLEGE OF ENG, KOTTUKULAM, PATHAMUTTOM SREE BUDDHA COLLEGE OF ENGG. PATTOOR, ALAPUZHA ST. JOSEPH'S COLLEGE OF ENGG. & TECH, KOTTAYAM DIST. MUSALIAR COLLEGE OF ENGG. & TECH, PATTANAMTHITTA YUNUS COLLEGE OF ENGG. & TECH, KOLLAM MARY MATHA COLLEGE OF ENGG. & TECH, NEYYATTINKARA TRAVANCORE COLLEGE OF ENGINEERING, KOLLAM P.A. AZIZ COLLEGE OF ENG & TECH, KARAKULAM BASIOUS MATHEWS II COLLEGE OF ENG, KOLLAM UNIVERSITY COLLEGE OF ENGG, TRIVANDRUM MAR BASELIOUS COLLEGE OF ENG, PEERMADE IDUKKI COLLEGE OF ENG, CHENGANNUR, ALAPPUZHA DIST. MODEL ENGINEERING COLLEGE, THRIKKAKARA, KOCHI CAARMEL ENGG. COLLEGE, KOONMKARA P.O., PERUNAD, RANNI, PATHANAMTHITTA YOTHI ENGINEERING COLLEGE, CHERUTHURUTHY, VETTIKATTIRI P.O., THRISSUR ES COLLEGE OF ENGINEERING, THRISSUR OYAL ENGINEERING COLLEGE, THRISSUR VIDYA ACADEMY OF SCIENCE AND TECHNOLOGY, THRISSUR NEHRU COLLEGE OF ENGG. & RESEARCH CENTRE, THRISSUR</p>
---	--

And Growing.....

International Customers List

Volvo, Sweden
Ericsson, Sweden
Nokia, Sweden
Siemens, Sweden
Alkatel, Sweden
Bofors, Sweden
FCC (US FCC authority)
PCB Technologies, Italy
Delta Control Systems Canada
Unicraft, Japan
Technologia Tecom S.L, Spain
R.K System, Poland
West Test, Germany
Mercure Telecom, France
Jeppson, Sweden
Industry Electronics, Czech Republic
Software Sistemas Especializados Ltda, Colombia
Elecsys, Korea
VESL Technologies, Tanzania
Test & Rework Solutions (Pty) Ltd, South Africa
Swifteurotech, U.K
Whingate, U.K
Toyota, Japan

List of Companies in India Using EDWinXP

DRDO, Bangalore
DRDE, Gwalior, Madhya Pradesh
HAL, Bangalore
TATA Institute of Fundamental Research, Mumbai
CDAC, Bangalore

Contact us:

Ambition Technologies

206, 2nd floor, Deepak Plaza, Sector-9
Dc Chowk, Rohini, New Delhi-110085

info@ambitiontech.com

www.ambitiontech.com

011-32041225/45733636/09810400671/09911223020